

Panasonic®

Operating Instructions

5.8 GHz Digital Cordless Phone

Model No. **KX-TG5428**

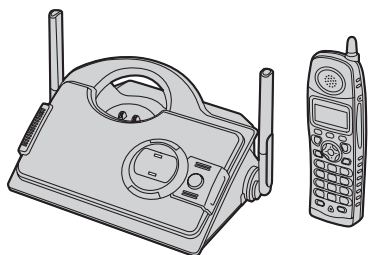

This unit is compatible with Caller ID. To use this feature, you must subscribe to the appropriate service offered by your service provider.

Charge the battery for 6 hours before initial use.

Please read these Operating Instructions before using the unit and save for future reference.

For assistance, visit our website: <http://www.panasonic.com> for customers in the U.S.A. or Puerto Rico.

Table of Contents

Introduction

Accessory information	5
Important safety instructions	6
For best performance	8

Preparation

Connections	9
Battery installation	10
Battery charge	11
Battery replacement	12
Controls and displays	13
Controls	13
Display	15

Making/Answering Calls

Making calls	16
Answering calls	17
Useful features during a call	18
HOLD button	18
MUTE button	18
Voice enhancer	18
Clarity booster	19
PAUSE button (for PBX/long distance service users)	19
Flash button	19
For Call Waiting service users	20
Temporary tone dialing (for rotary/pulse service users)	20
Handset locator	20

Phonebook

Using the phonebook	21
Adding items to the phonebook	21
Calling someone in the phonebook	22
Editing items in the phonebook	22
Erasing items in the phonebook	22
Chain dial feature	23

Caller ID Service

Using Caller ID service	24
Ringer ID and light-up ID	24
Caller list	25
Viewing the caller list and calling back	25
Editing a caller's phone number before calling back	26
Storing caller information into the phonebook	27

Erasing caller information	27
--------------------------------------	----

Voice Mail Service

Using Voice Mail service	28
Storing the Voice Mail (VM) access number	28
Voice Mail (VM) Tone Detection	28
Listening to Voice Mail messages	29
Message alert	29

Programmable Settings

Guide to handset programming	30
Ringer settings	31
Handset ringer volume	31
Handset ringer tone	31
Call options	32
Auto talk	32
Voice enhancer	32
Caller ID edit	32
Display options	33
Handset LCD contrast	33
Display language	33
Telephone settings	33
Dialing mode	33
Flash time	33
Line mode	34
Other options	34
Handset key tone	34
Re-registering the handset	35
Customer support	35
Programming via direct commands	36
Direct commands chart	36

Useful Information

Wall mounting	38
Belt clip	40
Headset (optional)	40
Error messages	41
Troubleshooting	42
General use	42
Programmable settings	42
Making/answering calls, Paging	43
Phonebook	43
Caller ID	44
Battery charge	45
Power failure	45
Important information about subscription services	46

FCC and other information 47
Technical information 50
 Base unit 50
 Handset 50
Warranty 51
Customer services 53

Index

Index 54

Introduction

Thank you for purchasing a Panasonic cordless telephone.

We recommend keeping a record of the following information for future reference.

Serial No. _____ Date of purchase _____
(found on the bottom of the unit)

Name and address of dealer _____

┌-----┐
| **Attach your purchase receipt here.** |
└-----┘

Energy Star:

As an ENERGY STAR® Participant, Panasonic has determined that this product meets the ENERGY STAR guidelines for energy efficiency. ENERGY STAR is a U.S. registered mark.



Accessory information

Included accessories

To order replacement accessories, call 1-800-332-5368.

TTY users (hearing or speech impaired users) can call 1-866-605-1277.

No.	Accessory items	Order number	Quantity
①	AC adaptor for base unit	PQLV1Z	1
②	Telephone line cord	PQJA10075Z	1
③	Wall mounting adaptor	PQKL10057Z1	1
④	Battery	HHR-P104	1
⑤	Handset cover	PQKK10584Z4	1
⑥	Belt clip	PQKE10389Z1	1

①

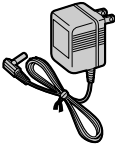

②



③

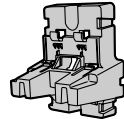

④

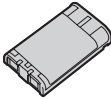

⑤

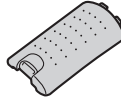

⑥



Additional/replacement accessories

Accessory items	Order number
Rechargeable nickel metal hydride (Ni-MH) battery	HHR-P104
Headset	KX-TCA60, KX-TCA86, KX-TCA88, KX-TCA88HA, KX-TCA91, KX-TCA92, or KX-TCA98
Battery back-up power supply	KX-TCA200

Important safety instructions

When using this unit, basic safety precautions should always be followed to reduce the risk of fire, electric shock, or personal injury.

1. Read and understand all instructions.
2. Follow all warnings and instructions marked on this unit.
3. Unplug this unit from power outlets before cleaning. Do not use liquid or aerosol cleaners. Use a damp cloth for cleaning.
4. Do not use this unit near water, for example near a bathtub, wash bowl, kitchen sink, etc.
5. Place the unit securely on a stable surface. Serious damage and/or injury may result if the unit falls.
6. Do not cover slots and openings on the unit. They are provided for ventilation and protection against overheating. Never place the unit near radiators, or in a place where proper ventilation is not provided.
7. Use only the power source marked on the unit. If you are not sure of the type of power supplied to your home, consult your dealer or local power company.
8. Do not place objects on the power cord. Install the unit where no one can step or trip on the cord.
9. Do not overload power outlets and extension cords. This can result in the risk of fire or electric shock.
10. Never push any objects through slots in this unit. This may result in the risk of fire or electric shock. Never spill any liquid on the unit.
11. To reduce the risk of electric shock, do not disassemble this unit. Take the unit to an authorized service center when service is required. Opening or removing covers may expose you to dangerous voltages or other risks.

Incorrect reassembly can cause electric shock when the unit is subsequently used.

12. Unplug this unit from power outlets and refer servicing to an authorized service center when the following conditions occur:
 - A. When the power cord is damaged or frayed.
 - B. If liquid has been spilled into the unit.
 - C. If the unit has been exposed to rain or water.
 - D. If the unit does not work normally by following the operating instructions. Adjust only controls covered by the operating instructions. Improper adjustment may require extensive work by an authorized service center.
 - E. If the unit has been dropped or physically damaged.
 - F. If the unit exhibits a distinct change in performance.
13. During thunderstorms, avoid using telephones except cordless types. There may be a remote risk of an electric shock from lightning.
14. Do not use this unit to report a gas leak, when in the vicinity of the leak.

SAVE THESE INSTRUCTIONS

CAUTION:

Installation

- Never install telephone wiring during a lightning storm.
- Never install telephone jacks in wet locations unless the jack is specifically designed for wet locations.
- Never touch uninsulated telephone wires or terminals unless the telephone line has been disconnected at the network interface.
- Use caution when installing or modifying telephone lines.

- Do not touch the plug with wet hands.
- The AC adaptor is used as the main disconnect device. Ensure that the AC outlet is installed near the unit and is easily accessible.

Battery

To reduce the risk of fire or injury to persons, read and follow these instructions.

- Use only the battery(ies) specified.
- Do not dispose of the battery(ies) in a fire. They may explode. Check with local waste management codes for special disposal instructions.
- Do not open or mutilate the battery(ies). Released electrolyte is corrosive and may cause burns or injury to the eyes or skin. The electrolyte may be toxic if swallowed.
- Exercise care when handling the battery(ies). Do not allow conductive materials such as rings, bracelets or keys to touch the battery(ies), otherwise a short circuit may cause the battery(ies) and/or the conductive material to overheat and cause burns.
- Charge the battery(ies) provided with or identified for use with this product only in accordance with the instructions and limitations specified in this manual.

WARNING:

- To prevent the risk of fire or electrical shock, do not expose this product to rain or any type of moisture.

Medical

- Consult the manufacturer of any personal medical devices, such as pacemakers or hearing aids, to determine if they are adequately shielded from external RF (radio frequency) energy. (The unit operates in the frequency range of 5.76 GHz to 5.84 GHz, and the power output level can range from 0.25 to 0.5 watts.) Do not use

the unit in health care facilities if any regulations posted in the area instruct you not to do so. Hospitals or health care facilities may be using equipment that could be sensitive to external RF (radio frequency) energy.

Splash-resistant (handset only)

The handset is designed to be splash-resistant.

You can use the handset with wet hands.

- Do not immerse in water or leave under running water.
- Keep the handset away from salt water.
- Avoid exposure to prolonged high humidity.
- Since water in headset jack may cause damage, close the headset jack cover when the optional headset is not in use. When the optional headset is connected, do not use the handset with wet hands.
- If the handset is wet, wipe with a soft dry cloth.
- The base unit is not designed to be splash resistant. Do not place the handset on the base unit if the handset is wet.

Shock-resistant (handset only)

The handset is designed to be shock-resistant, however, it should not be thrown or stepped on.

For best performance

Base unit location/noise

The base unit and handset use radio waves to communicate with each other. For maximum distance and noise-free operation, we recommend the following:

- Placing the unit away from electrical appliances such as a TV, personal computer or another cordless phone.
- Placing the base unit in a HIGH and CENTRAL location with no obstructions such as walls.
- Raising the antennas vertically.
- If you use the handset near a microwave oven which is being used, noise may be heard. Move away from the microwave oven and closer to the base unit.
- If you use the handset near another cordless phone's base unit, noise may be heard. Move away from the other cordless phone's base unit and closer to your base unit.

Environment

- Keep the unit away from electrical noise generating devices, such as fluorescent lamps and motors.
- The unit should be kept free from excessive smoke, dust, high temperature and vibration.
- The unit should not be exposed to direct sunlight.
- Do not place heavy objects on top of the unit.
- When you leave the unit unused for a long period of time, unplug this unit from power outlet.
- The unit should be kept away from heat sources such as heaters, kitchen stoves, etc. It should not be placed in rooms where the temperature is less than 5 °C (41 °F) or greater than 40 °C (104 °F). Damp basements should also be avoided.

- The maximum calling distance may be shortened when the unit is used in the following places: Near obstacles such as hills, tunnels, undergrounds, near metal objects such as wire fences, etc.
- Operating near 5.8 GHz electrical appliances may cause interference. Move away from the electrical appliances.

Routine care

- Wipe the outer surface of the unit with a soft cloth. Do not use benzine, thinner or any abrasive powder.

Connections

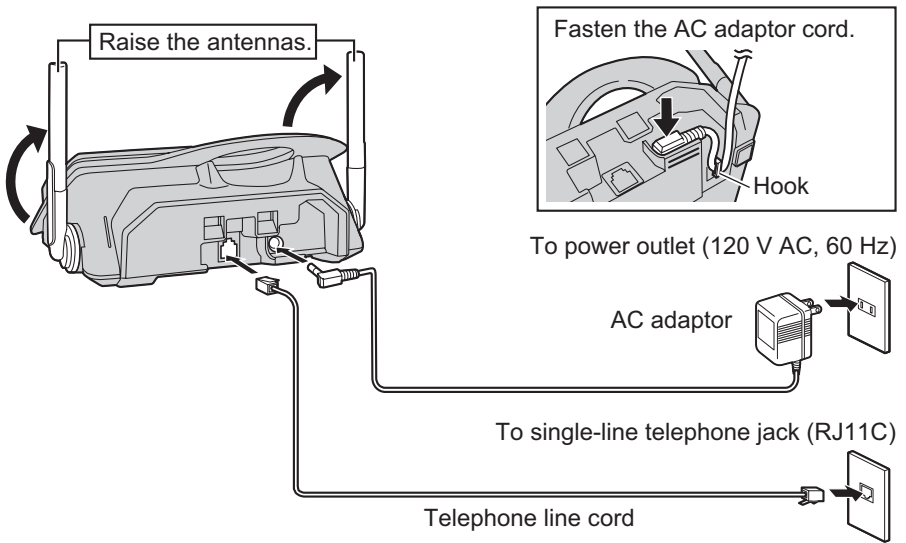

Note:

- Use only the included Panasonic AC adaptor PQLV1.
- The AC adaptor must remain connected at all times. (It is normal for the adaptor to feel warm during use.)
- The AC adaptor should be connected to a vertically oriented or floor-mounted AC outlet. Do not connect the AC adaptor to a ceiling-mounted AC outlet, as the weight of the adaptor may cause it to become disconnected.
- The unit will not work during a power failure. We recommend connecting a standard telephone to the same telephone line or to the same telephone jack using the Panasonic KX-J66 T-adaptor. Emergency power can be supplied to the unit by connecting a Panasonic battery back-up power supply noted on page 5.

Preparation

If you subscribe to an xDSL service

- Please attach a noise filter (contact your xDSL provider) to the telephone line between the base unit and the telephone line jack in the event of the following:
 - Noise is heard during conversations.
 - Caller ID features (page 24) do not function properly.

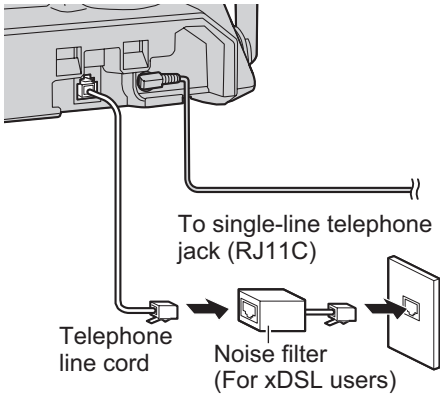

Battery installation

- 1 Release the battery cover latch and slide the cover open.

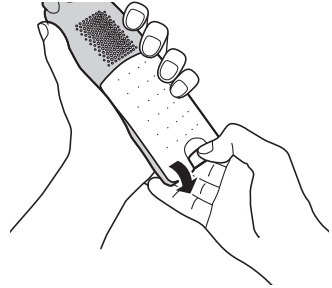

- 2 Insert the battery (①), and press it down until it snaps into the compartment (②).

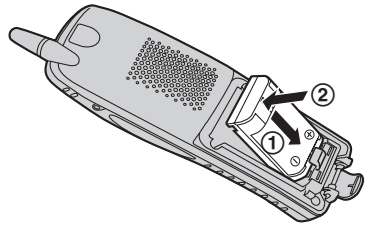

- 3 Close the handset cover.

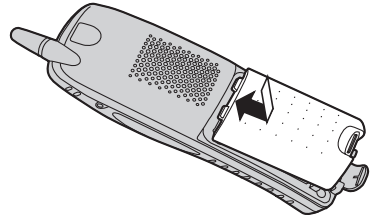

- 4 Fasten the battery cover latch.

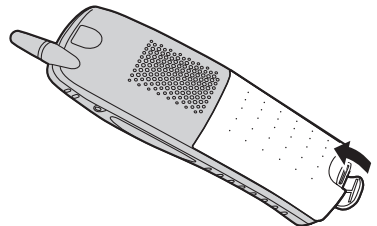

Battery charge

Place the handset on the base unit for **6 hours** before initial use.

- The unit will beep once, the CHARGE indicator will light, and “Charging” will be displayed.
- “Charge completed” is displayed when the battery has been fully charged. The CHARGE indicator will remain lit.

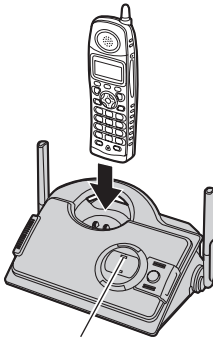

CHARGE indicator

Note:

- To ensure the battery charges properly, clean the charge contacts of the handset and base unit with a soft, dry cloth once a month. Clean more often if the unit is subject to grease, dust, or high humidity.

Battery strength

You can confirm the battery strength on the handset display.

Battery icon	Battery strength
	Fully charged
	Medium
	Low When flashing: needs to be recharged.
	Discharged

Recharging the battery

Recharge the battery when:

- “Recharge battery” is displayed or flashes on the handset display.
- the handset beeps intermittently while it is in use.

Note:

- Recharge the handset battery for more than 15 minutes, or the display will continue showing the indication.
- If the battery has been discharged, the handset will display “Charge for 6h” and when you place the handset on the base unit.

Preparation

Battery performance

After your Panasonic battery is fully charged, you can expect the following performance:

Operation	Operating time
While in use (talking)	Up to 5 hours
While not in use (standby)* ¹	Up to 11 days
While using the Clarity Booster feature (page 19)	Up to 3 hours



*¹ Handset is off the base unit but not in use.

Note:

- Battery power is consumed whenever the handset is off the base unit, even when the handset is not in use. The longer you leave the handset off the base unit, the shorter you can actually talk on the handset. Actual battery performance depends on a combination of how often the handset is in use and how often it is not in use.
- Once the battery is fully charged, you do not have to charge it again until "Recharge battery" is displayed or  flashes. This will maximize the battery life.

Battery replacement

If battery performance diminishes, make sure you have cleaned the charge contacts and fully charged the battery. The battery needs to be replaced if any of the following are displayed after a few phone calls even when you have fully charged the battery.

- "Recharge battery"
-  (flashing)
- "Charge for 6h"
- 
- Use only the rechargeable Panasonic battery noted on page 5.

- 1 Release the battery cover latch and slide the cover open.

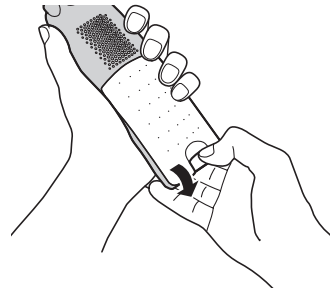

- 2 Replace the old battery with a new one, and close the cover (see page 10 for battery installation).

Attention:



A nickel metal hydride battery that is recyclable powers the product you have purchased. Please call 1-800-8-BATTERY for information on how to recycle this battery.

Controls and displays

Controls

Base unit

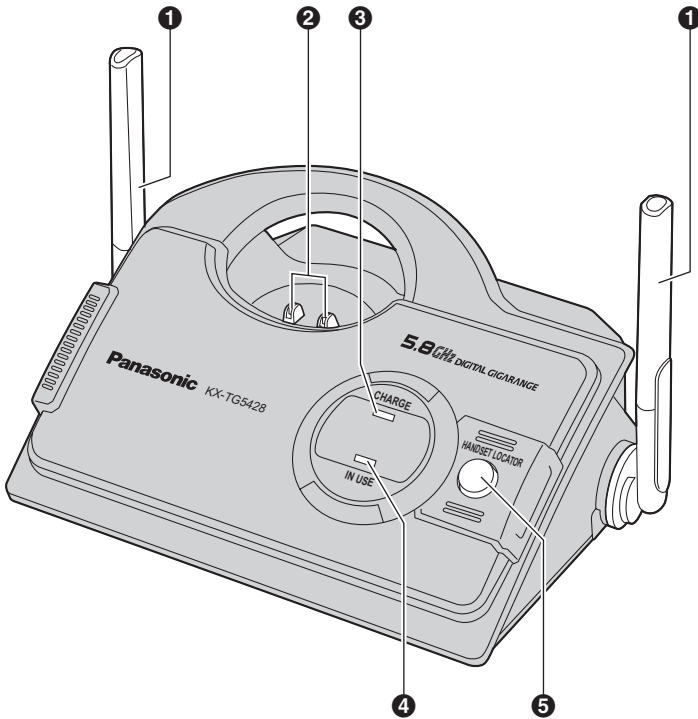

- ❶ Antenna
- ❷ Charge contacts
- ❸ CHARGE indicator
- ❹ IN USE indicator
- ❺ [HANDSET LOCATOR]

Preparation

Handset

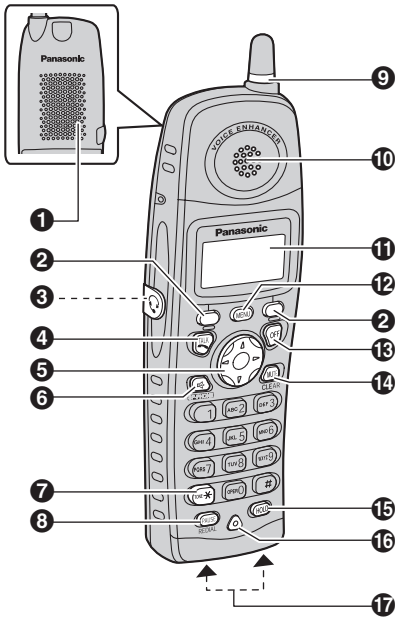

- ❶ Speaker
- ❷ Soft key
- ❸ Headset jack
- ❹ [↶] (TALK)
- ❺ Navigator key
- ❻ [☎] (SP-PHONE)
- ❼ [*] (TONE)
- ❽ [PAUSE][REDIAL]
- ❾ Ringer indicator
Message indicator
- ❿ Receiver
- ⓫ Display
- ⓬ [MENU]
- ⓭ [OFF]
- ⓮ [MUTE] [CLEAR]
- ⓯ [HOLD]
- ⓰ Microphone
- ⓱ Charge contacts

Using the navigator key

The handset navigator key can be used to navigate through menus and to select items shown on the display, by pressing [▲], [▼], [◀], or [▶].

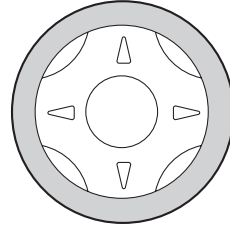

Display

Handset display items

Displayed item	Meaning
Ⓜ	Voice enhancer is on.
█	Battery strength

Soft keys

The handset features 2 soft keys. By pressing a soft key, you can select the function displayed directly above it.

- The functions displayed will vary depending on how you are using the unit.
- When a function does not appear above a soft key, the soft key has no function.

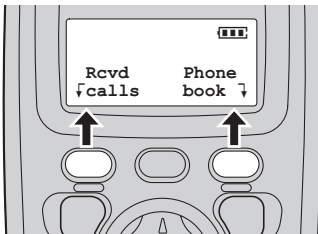

Soft key examples:

Display function	Action
Rcvd calls	Enters caller list
VM	Dials Voice Mail access number

Backlit display and handset keypad

The handset display and dialing buttons will light for a few seconds after pressing any of the handset's controls or lifting the handset off the base unit. They will also light when a call is being received.

Making calls

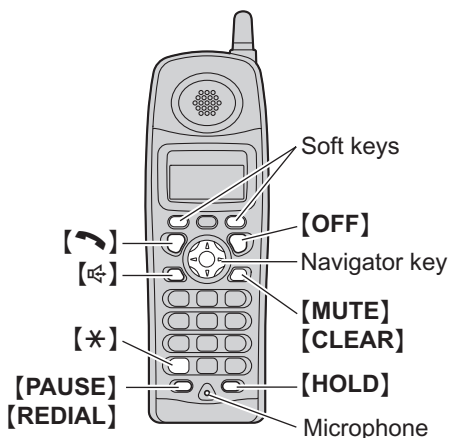

- 1 Lift the handset and press [↵].
 - “Talk” will be displayed.
- 2 Dial the phone number.
- 3 When finished talking, press [OFF] or place the handset on the base unit.

Note:

- “Line in use” is displayed when someone is talking on another phone.

To adjust the receiver volume

3 levels (high/medium/low) are available. While using the receiver, press [▼] or [▲] repeatedly.

To use the speakerphone

- 1 Lift the handset and press [↵].
 - “SP-phone” will be displayed.
- 2 Dial the phone number.
- 3 When the other party answers, speak into the microphone.
- 4 When finished talking, press [OFF] or place the handset on the base unit.

Note:

- Talk alternately with the caller in a quiet room.
- If the other party has difficulty hearing you, press [▼] to decrease the speaker volume.
- While on a call, you can switch from the receiver to the speakerphone by pressing [↵]. To switch back to the receiver, press [↶].

To adjust the speaker volume

6 levels (high to low) are available. While using the speaker, press [▼] or [▲] repeatedly.

To dial after confirming the entered number

- 1 Enter the phone number.

Example:



- To correct a digit, press [◀] or [▶] to move the cursor, then press [CLEAR]. Enter the correct number.
 - If a pause is required when dialing, press [PAUSE] where needed (page 19).
 - To cancel, press [OFF].
- 2 Press [↶], [↵], or [Call].
 - 3 When finished talking, press [OFF] or place the handset on the base unit.

To redial the last number dialed

- 1 Press [↶] or [↵].
- 2 Press [REDIAL].

To make a call using the redial list

The last 5 phone numbers dialed are stored in the redial list.

- 1 Press **[REDIAL]**.
 - The last number dialed will be displayed.
- 2 Press **[▼]** or **[▲]** repeatedly to display the desired number.
 - To delete the displayed number, press **[CLEAR]**.
 - To exit the list, press **[OFF]**.
- 3 Press **[↶]**, **[☎]**, or **[Call]**.

Answering calls

When a call is being received, the ringer indicator flashes rapidly.

- 1 Lift the handset and press **[↶]** or **[☎]**.
 - You can also answer a call by pressing any button except **[▼]**, **[▲]**, **[←]**, **[→]**, or **[OFF]**. (**Any key talk feature**)
- 2 When finished talking, press **[OFF]** or place the handset on the base unit.

Auto talk

This feature allows you to answer a call by simply lifting the handset off the base unit. You do not need to press **[↶]**. To activate this feature, see page 32.

Temporary ringer off

While the handset is ringing for an outside call, you can turn the ringer off temporarily by pressing **[OFF]**. The handset will ring the next time a call is received.

Useful features during a call

HOLD button

This feature allows you to put an outside call on hold.

Press **[HOLD]** during an outside call.

- “Hold” will be displayed.
- To return to the call, press **[↶]** or **[↷]**.

Note:

- If another phone is connected on the same line (page 9), you can also take the call by lifting its handset.
- If a call is kept on hold for more than 6 minutes, an alarm tone will start to sound and the ringer indicator will flash rapidly. After 4 additional minutes on hold, the call will be disconnected.

MUTE button

You can mute your voice during a conversation. While mute is turned on you will be able to hear the other party, but the other party will not be able to hear you.

To mute your voice, press **[MUTE]**.

Example:

Talk
00-00-30 <Mute>

- “<Mute>” will flash on the display.
- To return to the conversation, press **[MUTE]**, **[↶]**, or **[↷]**.

Voice enhancer

This feature clarifies the voice of the person you are talking to, reproducing a more natural-sounding voice that is easier to hear and understand.

- 1 Press **[MENU]** during an outside call.
- 2 To turn this feature on or off, press **[3]**.
 - You can also select “V.E. on” or “V.E. off” by pressing **[▼]** or **[▲]** then pressing **[▶]**.

▶3=V.E. on

- When turned on, “**(V)**” will be displayed.

Note:

- Once you turn voice enhancer on, it will be activated for all outside calls until turned off.
- You can also turn this feature on or off by programming (page 32).
- Depending on the condition and quality of your telephone line, this feature may emphasize existing line noise. If it becomes difficult to hear, turn this feature off.

Clarity booster

This feature can improve sound clarity when the handset is used in an area where there may be interference. During an outside call, this feature will be turned on automatically when necessary. This feature will turn off when you hang up or put a call on hold. It will not turn off automatically during a call. You can also turn this feature on or off manually.

- 1 Press **[MENU]** during an outside call.
- 2 Press **[2]** to select “**Booster on**” or “**Booster off**”.
 - You can also select “**Booster on**” or “**Booster off**” by pressing **[▼]** or **[▲]** then pressing **[▶]**.

1=Phonebook ▶2=Booster on

- While this feature is turned on, “**BOOST**” will flash on the display.

Note:

- If this feature is turned off manually during a call, it will not be turned on automatically during the same call.
- While this feature is turned on, battery operating time will be shortened (page 12).

PAUSE button (for PBX/long distance service users)

A pause is sometimes required when making calls using a PBX or long distance service.

For example, if you need to dial the line access number “9” when making outside calls with a PBX:

- 1 Press **[9]**.
- 2 Press **[PAUSE]**, then dial the phone number.

Example:

9P15556667777
↓Flash Call↓

- 3 Press **[↶]**, **[☎]**, or **[Call]**.

Note:

- A 3.5 second pause is inserted each time **[PAUSE]** is pressed. Press repeatedly to insert longer pauses.

Flash button

Pressing **[Flash]** allows you to use special features of your host PBX such as transferring an extension call, or accessing optional telephone services such as Call Waiting.

Example:

Talk 00-00-20 ↓Flash

Note:

- To change the flash time, see page 33.

For Call Waiting service users

To use Call Waiting, you must subscribe to your telephone company's Call Waiting service.

This feature allows you to receive calls while you are already talking on the phone. If you receive a call while on the phone, you will hear a Call Waiting tone.

Press **[Flash]** to answer the 2nd call.

- The 1st call is put on hold while you answer the 2nd call.
- To switch between calls, press **[Flash]**.

Note:

- Please contact your telephone company for details and availability of this service in your area.

Temporary tone dialing (for rotary/pulse service users)

You can temporarily switch the dialing mode to tone when you need to access touch tone services (for example, answering services, telephone banking services, etc.).

Press **[*]** (TONE) before entering access numbers which require tone dialing.

Note:

- The dialing mode will return to pulse when you hang up.

Handset locator

You can locate a misplaced handset by paging it from the base unit.

1 Base unit:

Press **[HANDSET LOCATOR]** to page the handset.

- The IN USE indicator will flash rapidly.
- The handset will beep for 1 minute.

2 Base unit:

To stop paging, press **[HANDSET LOCATOR]**.

OR

Handset:

To stop paging, press **[OFF]**.

Using the phonebook

The handset phonebook allows you to make calls without having to dial manually. You can add 50 names and phone numbers to the handset phonebook and search for phonebook entries by name.

Adding items to the phonebook

1 Press **[Phonebook]**.

```
Rcvd      Phone
↓calls    book ↓
```

2 Press **[Add]**.

- The display shows the number of items in the phonebook.

Example:

```
Phonebook
  7 items
↓Add      Search↓
```

3 Enter the name (max. 16 characters). See the character table for entry.

```
Enter name
█
↓Back      Next↓
```

4 Press **[Next]**.

5 Enter the phone number (max. 32 digits).

- If a pause is required when dialing, press **[PAUSE]** where needed (page 19).

```
Enter phone no.
```

6 Press **[Next]**.

- If you want to change the name and number, press **[Edit]**, then repeat from step 3.

Example:

```
Tom
555-765-4321
↓Edit      Save↓
```

7 Press **[Save]**.

- To add other items, repeat from step 2.

8 Press **[OFF]**.

Note:

- Caller ID subscribers can use ringer ID and light-up ID features (page 24).

Character table

The dial keys can be used to enter characters. To enter a character, press the appropriate dial key, repeatedly if necessary. To enter another character that is located on the same dial key, first press **[▶]** to move the cursor to the next space.

Key	Characters
[1]	& ' () , - . / 1
[2]	a b c A B C 2
[3]	d e f D E F 3
[4]	g h i G H I 4
[5]	j k l J K L 5
[6]	m n o M N O 6
[7]	p q r s P Q R S 7
[8]	t u v T U V 8
[9]	w x y z W X Y Z 9
[0]	0 Space
[*]	*
[#]	#
[CLEAR]	To delete a character or number

To edit/correct a mistake

Press **[◀]** or **[▶]** to move the cursor to the character or number you wish to erase, then press **[CLEAR]**. Enter the appropriate character or number.

Note:

- Press and hold **[CLEAR]** to erase all characters or numbers.

Calling someone in the phonebook

Phonebook items can be searched for alphabetically by scrolling through the phonebook items.

- 1 Press **[Phonebook]**.
 - For quick search, you can skip to step 3.

- 2 Press **[Search]**.

0-9=Name search ▼▲=Scroll list

- 3 Press **[▼]** or **[▲]** repeatedly to display the desired item.
 - To exit the phonebook, press **[OFF]**.

- 4 Press **[↶]** or **[↷]**.

Note:

- To view a phone number over 16 digits long, follow steps 1 to 3, then press **[Edit]** and **[Next]**. Press **[OFF]** when finished.

To search for a name by initial

- 1 Press **[Phonebook]**, then press **[Search]**.
- 2 Press the dialing button (**[0]** to **[9]**, **[#]**, or **[*]**) which corresponds to the first letter you are searching for (see the character table, page 21).
Example: "LISA"
Press **[5]** repeatedly to display any name with the initial "L".
 - If there is no item corresponding to the letter you selected, the next item will be displayed.
- 3 Press **[▼]** repeatedly to display the desired item.
 - To exit the phonebook, press **[OFF]**.
 - To dial the displayed number, press **[↶]** or **[↷]**.

Editing items in the phonebook

- 1 Press **[Phonebook]**, then press **[Search]**.
- 2 Press **[▼]** or **[▲]** repeatedly to display the desired item.
- 3 Press **[Edit]**.
- 4 Edit the name if necessary. See the character table on page 21 for character entry.
- 5 Press **[Next]**.
- 6 Edit the phone number if necessary.
- 7 Press **[Next]**, then press **[Save]**.
 - To edit other items, repeat from step 2.
- 8 Press **[OFF]**.

Erasing items in the phonebook

- 1 Press **[Phonebook]**, then press **[Search]**.
- 2 Press **[▼]** or **[▲]** repeatedly to display the desired item.
- 3 Press **[CLEAR]**.
- 4 Press **[Yes]**.
 - To cancel erasing, press **[No]**.
 - To erase other items, repeat from step 2.
- 5 Press **[OFF]**.

Chain dial feature

This feature allows you to dial phone numbers from the phonebook while you are on a call.

Example: Using a long distance calling card

- ① Dial from the phonebook:
1-800-012-3456 (Calling card access number).
- ② When prompted, dial from the phonebook:
1234 (Calling card PIN).
- ③ When prompted, dial from the phonebook:
1-555-012-3456 (the person you want to call).

- 1** During an outside call, press **[MENU]**.
- 2** Press **[1]** to select "Phonebook".
- 3** Press **[▼]** or **[▲]** repeatedly to display the desired item.
- 4** Press **[Call]**.
 - Repeat from step 1 to dial other numbers.

Note:

- When storing a calling card access number and your PIN in the phonebook as one phonebook item, press **[PAUSE]** to add pauses after the number and PIN as necessary (page 19).
- If you have rotary or pulse service, you need to press **[*]** before pressing **[MENU]** in step 1 to change the dialing mode temporarily to tone.

Using Caller ID service

This unit is Caller ID compatible. To use Caller ID features, you must subscribe to your telephone company's Caller ID service.

Caller ID features

When an outside call is being received, the calling party's name or telephone number will be displayed.

Caller information for the last 50 different callers will be logged in the caller list, allowing you to return missed calls. Caller information is stored by the most recent call to the oldest.

- When Caller ID information is received and it matches a phone number stored in the phonebook:
 - The stored name will be displayed and logged in the caller list. (**Personalized name display**)
 - The handset will use the ringer tone and the ringer indicator color you assigned to the caller. (**Ringer ID and light-up ID**)
- If the unit cannot receive caller information, the following will be displayed:
 - “**Out of area**”: The caller dialed from an area which does not provide Caller ID service.
 - “**Private caller**”: The caller requested not to send caller information.
 - “**Long distance**”: The caller called you long distance.
- If the unit is connected to a PBX system, caller information may not be received properly. Consult your PBX supplier.

Call Waiting Caller ID display

If you subscribe to both Caller ID and Call Waiting with Caller ID services, the 2nd caller's information will be displayed after you hear a Call Waiting tone (page 20).

Example:

BROWN, NANCY
1-555-666-7777
↓Flash -Waiting-

Note:

- Please contact your telephone company for details and availability of this service in your area.

Ringer ID and light-up ID

This feature can help you identify who is calling by using different ringers and ringer indicator colors for different callers stored in the phonebook. You can assign a different ringer and indicator color to each phonebook item. When a call is received from a caller stored in the phonebook, the ringer and indicator color are used after Caller ID information is displayed.

- Usually the ringer and indicator color will be changed from the 2nd ring.

Ringer ID

You can assign a different ringer tone to each caller in the phonebook. If you select “**No Ringer ID**”, the unit will use the ringer tone you set on page 31 when a call is received from that caller. The default setting is “**No Ringer ID**”.

- 1 Press [**Phonebook**], then press [**Search**].
- 2 Press [**▼**] or [**▲**] repeatedly to display the desired item.
- 3 Press [**Option**].
- 4 Press [**1**] to select “**Ringer ID**”.
- 5 Press [**▼**] or [**▲**] repeatedly to select the desired ringer tone.

- You can also select the ringer tone by pressing **[1]** to **[7]**, or **[0]** (“No Ringer ID”).

6 Press **[Save]**, then press **[OFF]**.

Light-up ID

You can assign a different ringer indicator color to each caller in the phonebook. Select “Color1-Default” (Amber), “Color2” (Green), “Color3” (Red), or “Multicolor”.

- 1 Press **[Phonebook]**, then press **[Search]**.
- 2 Press **[v]** or **[▲]** repeatedly to display the desired item.
- 3 Press **[Option]**.
- 4 Press **[2]** to select “Light-up ID”.
- 5 Press **[v]** or **[▲]** repeatedly to select the desired ringer indicator color.
 - You can also select the color by pressing **[1]** to **[4]**.
- 6 Press **[Save]**, then press **[OFF]**.

Caller list

Caller information for the last 50 different callers will be logged in the caller list. You can use this list to return missed calls.

- Caller information includes caller names and phone numbers, the date and time of calls, and the number of times the caller called.

Missed calls

If a call is not answered, the unit treats the call as a missed call. The number of missed calls is shown on the handset display. This lets you know if you should view the caller list to see who called while you were out.

Example: Handset off the base unit

10 missed calls	
Rcvd	Phone
↓calls	book ↓

Note:

- When new messages are recorded in your Voice Mail (page 28), you will see “Voice Mail” instead of “missed calls”.

Viewing the caller list and calling back

- 1 Press **[v]** or **[▲]** to enter the caller list.
- 2 Press **[v]** to search from the most recent call, or press **[▲]** to search from the oldest call.
 - The caller’s name and phone number are displayed alternately.

Example:

SMITH, JACK 3:10P JUN.29
↑ ↓
1-555-333-4444 3:10P JUN.29

- To exit the caller list, press **[OFF]**.
- 3 Press **[↶]** or **[☎]**.

Caller ID Service

Note:

- You can also press [**Rcvd calls**] to enter the caller list.
- Calling back will not be possible if the caller information does not include a phone number.
- In some cases, you may have to edit the number before dialing. (For example, you may have to delete “1” and the area code.)

Displayed symbols

- If the same caller calls more than once, it will be displayed with the number (“x2” to “x9”). Only the date and time of the most recent call will be stored.
- A ✓ is displayed next to items which have already been viewed or answered on this handset.

Editing a caller’s phone number before calling back

You can edit a phone number in the caller list by removing its area code and/or the long distance code “1”.

- 1 Press [**▼**] or [**▲**] to enter the caller list.
- 2 Press [**▼**] or [**▲**] repeatedly to display the desired item.
- 3 Press [**Edit**] repeatedly until the phone number is shown in the desired format. Each time you press [**Edit**], the phone number will be rearranged into one of 3 patterns.
 - ① Local phone number
Example:
 - ② Area code – Local phone number
Example:
 - ③ 1 – Area code – Local phone number
Example:
- 4 To return a call, press [**↶**] or [**☎**].

Caller ID number auto edit feature

Once you call back an edited number (see “Editing a caller’s phone number before calling back”), the unit can automatically edit other incoming phone numbers each time you receive a call.

For example, you can use this feature to set the unit to ignore the area code of callers in your area code, so that you can call these local numbers using caller information without dialing the area code. To activate this feature, you must edit an item in the caller list (see “Editing a caller’s phone number before calling back”), then call that number. After that, calls from that caller’s area code will be edited automatically.

This feature can be turned on or off (page 32). The default setting is ON.

Note:

- The handset can remember up to 4 area codes to be edited. Phone numbers from the 4 most recently edited area codes will be automatically edited.
- This feature will not be activated until edited numbers are called back.
- If you move to another area, you can turn this feature off to erase previously edited area codes. To use this feature again, turn it on and reprogram the area codes you want to edit once again.

Storing caller information into the phonebook

Items in the caller list can be stored into the phonebook.

- 1 Press [**▼**] or [**▲**] to enter the caller list.
- 2 Press [**▼**] or [**▲**] repeatedly to display the desired item.
 - To edit the number, press [**Edit**] repeatedly until the number is shown in the desired format (page 26, step 3).
- 3 Press [**Save**].
 - If there is no name information for the caller, “**Enter name**” will be displayed.
 - ① Enter the name if necessary (see page 21, step 3).
 - ② Press [**Next**], then press [**Save**].
 - To continue storing other items, repeat from step 2.
- 4 Press [**OFF**] to exit.

Note:

- If the caller information does not include a phone number, you cannot store it in the phonebook.

Erasing caller information

Erasing a selected item

- 1 Press [**▼**] or [**▲**] to enter the caller list.
- 2 Press [**▼**] or [**▲**] repeatedly to display the desired item.
- 3 Press [**CLEAR**].
 - To erase other items, repeat from step 2.
 - To exit the caller list, press [**OFF**].

Erasing all items

Make sure that you have no missed calls.

- 1 Press [**▼**] or [**▲**] to enter the caller list.
- 2 Press [**All erase**].
 - To cancel erasing, press [**No**].
- 3 Press [**Yes**].

Using Voice Mail service

Voice Mail is an automatic answering service offered by your telephone company. If you subscribe to this service, your telephone company's Voice Mail system can answer calls for you when you are unavailable to answer the phone or when your line is busy. Messages are recorded by the telephone company, not your telephone.

Note:

- Please contact your telephone company for details and availability of this service in your area.

Storing the Voice Mail (VM) access number

In order to listen to your Voice Mail messages (page 29), you must dial your telephone company's Voice Mail access number. Once you have stored your Voice Mail access number, you can dial it automatically by pressing **[VM]** (page 29).

- 1 Press **[MENU]**.
- 2 Scroll to "Initial setting" by pressing **[▼]** or **[▲]**, then press **[▶]**.
- 3 Scroll to "Voice Mail" by pressing **[▼]** or **[▲]**, then press **[▶]**.
- 4 Scroll to "Store VM access#" by pressing **[▼]** or **[▲]**, then press **[▶]**.
- 5 Enter your access number (max. 32 digits).
 - To correct a digit, press **[▶]** or **[◀]** to move the cursor, then press **[CLEAR]**. Enter the correct number.
 - If a pause is required when dialing, press **[PAUSE]** where needed (page 19).
- 6 Press **[Save]**, then press **[OFF]**.

Note:

- When storing your Voice Mail access number and your mailbox password, press **[PAUSE]** to add pauses (page 19) between the access number and the password as necessary. Consult your telephone company for the required pause time.

Example:

<u>1-222-333-4444</u>	<u>PPPP</u>	<u>8888</u>
VM access number	Pauses	Password

To erase the Voice Mail access number

Repeat steps 1 to 4, then press and hold **[CLEAR]** until all digits are erased. Press **[Save]**, then press **[OFF]**.

Voice Mail (VM) Tone Detection

Your telephone company sends special signals (sometimes called "Voice Mail tones" or "stutter tones") to the unit to let you know you have new Voice Mail messages. If you hear a series of dial tones followed by a continuous dial tone after you press **[☞]** or **[☜]**, you have new Voice Mail messages. Minutes after you hang up a call or after the phone stops ringing, your unit will check the phone line to see if new Voice Mail messages have been recorded. The default setting is ON. Turn this feature off when:

- You do not subscribe to Voice Mail service.
 - Your telephone company does not send Voice Mail tones.
 - Your phone is connected to a PBX.
- If you are not sure which setting is required, consult your telephone company.

Turning VM detection on/off

- 1 Press **[MENU]**.
- 2 Scroll to "Initial setting" by pressing **[▼]** or **[▲]**, then press **[▶]**.

- 3 Scroll to “**Voice Mail**” by pressing [▼] or [▲], then press [▶].
- 4 Scroll to “**VM tone detect**” by pressing [▼] or [▲], then press [▶].
- 5 Press [▼] or [▲] repeatedly to select “**On**” or “**Off**”.
- 6 Press [Save], then press [OFF].

Listening to Voice Mail messages

The unit will let you know that you have new Voice Mail messages in the following ways:

- “**Voice Mail**” will be displayed on the handset.
- The message indicator on the handset will flash slowly if message alert feature is turned on.

- 1 Press [📞] or [📞], then press [VM] within 15 seconds.
 - If [VM] is not displayed, the Voice Mail access number has not been stored. Store the number (page 28).OR
Press [MENU], then press [Select] at “**V.M. access**”.
 - The speakerphone will turn on.
- 2 Follow the pre-recorded instructions.
- 3 Press [OFF] when finished.

Note:

- If “**Voice Mail**” still remains on the display even after you have listened to new messages, turn it off by pressing and holding [OFF] until the handset beeps.
- If your Voice Mail service uses Voice Mail tones and the message is over 3 minutes long, the handset may not indicate new messages.
- If your Voice Mail service uses Voice Mail tones, the tones will be heard from any phone connected to the same line. If

you want to use another phone to listen to Voice Mail messages, you have to dial your access number manually.

Message alert

You can select whether or not the message indicator on the handset will flash when new messages have been recorded. The default setting is OFF.

- 1 Press [MENU].
- 2 Scroll to “**Initial setting**” by pressing [▼] or [▲], then press [▶].
- 3 Scroll to “**Message alert**” by pressing [▼] or [▲], then press [▶].
- 4 Press [▼] or [▲] repeatedly to select “**On**” or “**Off**”.
- 5 Press [Save], then press [OFF].

Note:

- The message indicator will not flash for new messages while the handset is in use.
- While message alert is on, battery operating time will be shortened (page 12).

Guide to handset programming

For your reference, a chart of all programmable functions is printed below. Details for each item can be found on the corresponding pages. To program, press **[MENU]**, press **[▼]** or **[▲]** to scroll through the menu, and press **[▶]** or **[Select]** when the desired menu item or setting is displayed.

Important:

- Before programming, make sure the handset is not being used. The handset must be operated near the base unit and while off the base unit.

Main menu	Sub-menu 1	Sub-menu 2	Page
V.M. access	–	–	page 29
Ringer setting	Ringer volume	–	page 31
	Ringer tone	–	page 31
Voice enhancer	–	–	page 32
Customer support	–	–	page 35
Initial setting	Voice Mail	Store VM access#	page 28
		VM tone detect	page 28
	Message alert	–	page 29
	LCD contrast	–	page 33
	Key tone	–	page 34
	Auto talk	–	page 32
	Caller ID edit	–	page 32
	Set tel line	Set dial mode	page 33
		Set flash time	page 33
		Set line mode	page 34
	Registration	–	page 35
Change language	–	page 33	

Note:

- To exit programming, press **[OFF]** at any time.
- To go back to the previous menu, press **[◀]** or **[Back]**, or press **[▶]** or **[Select]** while “(Go back)” is displayed.

Ringer settings

Handset ringer volume

4 levels (high/medium/low/off) are available. The default setting is HIGH.

- 1 Press **[MENU]**.
- 2 Scroll to “**Ringer setting**” by pressing **[▼]** or **[▲]**, then press **[▶]**.

Ringer setting

- 3 Scroll to “**Ringer volume**” by pressing **[▼]** or **[▲]**, then press **[▶]**.

Ringer volume

- 4 Press **[▼]** or **[▲]** repeatedly to select the desired volume.

Ringer volume
Low ■■■■■■ High
↓Back ▼▲ Save↓

- To turn the ringer off, press **[▼]** repeatedly until “**off ?**” is displayed.

- 5 Press **[Save]**.

Note:

- When the ringer volume is set to off, the handset will display “**Ringer off**”, and will not ring for outside calls. The handset will ring at the low level when paged by the base unit.

Handset ringer tone

You can change the ringer tone heard when an outside call is received. There are 3 tones and 4 melodies. The default setting is “**Tone 1**”.

- 1 Press **[MENU]**.
- 2 Scroll to “**Ringer setting**” by pressing **[▼]** or **[▲]**, then press **[▶]**.

Ringer setting

- 3 Scroll to “**Ringer tone**” by pressing **[▼]** or **[▲]**, then press **[▶]**.

Ringer tone

- 4 Press **[▼]** or **[▲]** repeatedly to select the desired setting.

Ringer tone
1= Tone 1
↓Back ▼▲ Save↓

- You can also select the ringer tone by pressing **[1]** to **[7]**.
- If the ringer volume has been turned off, the handset will not ring.

- 5 Press **[Save]**, then press **[OFF]**.

Note:

- If you subscribe to a distinctive ring service (such as IDENT-A-RING), select a tone (Tone 1 to 3). If you select a melody, you will not be able to distinguish lines by their ringers.
- If you select one of the melody ringer patterns, the ringer will continue to sound for several seconds if:
 - the caller hangs up before you answer the call.
 - another person answers the call using another phone connected on the same line.

Call options

Auto talk

When this feature is turned on, you can answer a call by lifting the handset off the base unit without pressing [↶]. The default setting is OFF.

- 1 Press [MENU].
- 2 Scroll to "Initial setting" by pressing [▼] or [▲], then press [▶].
- 3 Scroll to "Auto talk" by pressing [▼] or [▲], then press [▶].
- 4 Press [▼] or [▲] repeatedly to select the desired setting.
- 5 Press [Save], then press [OFF].

Note:

- If you subscribe to Caller ID service and want to view the caller's information on the handset display after lifting up the handset to answer a call, turn off this feature.

Voice enhancer

You can turn the voice enhancer feature on or off. The default setting is OFF.

- 1 Press [MENU].
- 2 Scroll to "Voice enhancer" by pressing [▼] or [▲], then press [▶].
- 3 Press [▼] or [▲] repeatedly to select "On" or "Off".
- 4 Press [Save], then press [OFF].
 - When turned on, "((☑))" will be displayed.

Caller ID edit

You can turn the Caller ID number auto edit feature (page 26) on or off. The default setting is ON.

- 1 Press [MENU].
- 2 Scroll to "Initial setting" by pressing [▼] or [▲], then press [▶].
- 3 Scroll to "Caller ID edit" by pressing [▼] or [▲], then press [▶].
- 4 Press [▼] or [▲] repeatedly to select "On" or "Off".
- 5 Press [Save], then press [OFF].

Display options

Handset LCD contrast

You can adjust the handset display contrast. There are 6 levels. The default setting is level 3.

- 1** Press **[MENU]**.
- 2** Scroll to “Initial setting” by pressing **[▼]** or **[▲]**, then press **[▶]**.
- 3** Scroll to “LCD contrast” by pressing **[▼]** or **[▲]**, then press **[▶]**.
- 4** Press **[▼]** or **[▲]** repeatedly to select the desired setting.
- 5** Press **[Save]**, then press **[OFF]**.

Display language

You can select either “English” (default) or “Español” as the display language.

- 1** Press **[MENU]**.
- 2** Scroll to “Initial setting” by pressing **[▼]** or **[▲]**, then press **[▶]**.
- 3** Scroll to “Change language” by pressing **[▼]** or **[▲]**, then press **[▶]**.
- 4** Press **[▼]** or **[▲]** repeatedly to select the desired language.
 - You can also select by pressing **[English]** or **[Español]**.
- 5** Press **[Save]** or **[Salvar]**, then press **[OFF]**.

Note:

- If you select a language you cannot read, press **[MENU] [0] [8] [1] [Save]** to change the display language to English.

Telephone settings

Dialing mode

If you cannot make calls, change this setting depending on your telephone line service.

“Tone” (default): For tone dial service.
 “Pulse”: For rotary pulse dial service.

- 1** Press **[MENU]**.
- 2** Scroll to “Initial setting” by pressing **[▼]** or **[▲]**, then press **[▶]**.
- 3** Scroll to “Set tel line” by pressing **[▼]** or **[▲]**, then press **[▶]**.
- 4** Scroll to “Set dial mode” by pressing **[▼]** or **[▲]**, then press **[▶]**.
- 5** Press **[▼]** or **[▲]** repeatedly to select the desired setting.
- 6** Press **[Save]**, then press **[OFF]**.

Flash time

The flash time depends on your telephone exchange or host PBX.

You can select: “90ms” (milliseconds), “100ms”, “110ms”, “250ms”, “300ms”, “400ms”, “600ms”, or “700ms” (default).

- 1** Press **[MENU]**.
- 2** Scroll to “Initial setting” by pressing **[▼]** or **[▲]**, then press **[▶]**.
- 3** Scroll to “Set tel line” by pressing **[▼]** or **[▲]**, then press **[▶]**.
- 4** Scroll to “Set flash time” by pressing **[▼]** or **[▲]**, then press **[▶]**.
- 5** Press **[▼]** or **[▲]** repeatedly to select the desired setting.
- 6** Press **[Save]**, then press **[OFF]**.

Programmable Settings

Note:

- The setting should stay at 700 ms unless pressing **[Flash]** fails to pick up the Call Waiting call.
- If the unit is connected via a PBX, certain PBX functions (call transferring, etc.) may not work correctly. Consult your PBX supplier for the correct setting.

Line mode

The line mode is preset to “B” and generally should not be adjusted. If “Line in use” on the handset is not displayed properly, the line mode selection is incorrect. Set line mode to “A”.

- 1** Press **[MENU]**.
- 2** Scroll to “Initial setting” by pressing **[▼]** or **[▲]**, then press **[▶]**.
- 3** Scroll to “set tel line” by pressing **[▼]** or **[▲]**, then press **[▶]**.
- 4** Scroll to “set line mode” by pressing **[▼]** or **[▲]**, then press **[▶]**.
- 5** Press **[▼]** or **[▲]** repeatedly to select the desired setting.
- 6** Press **[Save]**, then press **[OFF]**.

Other options

Handset key tone

You can select whether or not key tones are heard when keys are pressed. Includes confirmation tones and error tones. The default setting is ON.

- 1** Press **[MENU]**.
- 2** Scroll to “Initial setting” by pressing **[▼]** or **[▲]**, then press **[▶]**.
- 3** Scroll to “Key tone” by pressing **[▼]** or **[▲]**, then press **[▶]**.
- 4** Press **[▼]** or **[▲]** repeatedly to select “On” or “Off”.
- 5** Press **[Save]**, then press **[OFF]**.

Re-registering the handset

If “No link to base. Move closer to base, try again.” is displayed even when the handset is near the base unit, you may need to re-register the handset to the base unit.

Important:

- Make sure the base unit is not being used.
- Have the handset and base unit near each other when re-registering the handset.

1 Handset:

Press **[MENU]**.

2 Scroll to “Initial setting” by pressing **[▼]** or **[▲]**, then press **[▶]**.

3 Scroll to “Registration” by pressing **[▼]** or **[▲]**, then press **[▶]**.

4 Base unit:

Press and hold **[HANDSET LOCATOR]** until the CHARGE indicator flashes.

- After the CHARGE indicator starts flashing, the rest of the procedure must be completed within 1 minute.

5 Handset:

Press **[OK]**, then wait until the handset beeps.

- Registration is complete.

Customer support

The handset can display the Internet address where you can download operating instructions for this product using your computer.

1 Press **[MENU]**.

2 Scroll to “Customer support” by pressing **[▼]** or **[▲]**, then press **[▶]**.

- “www.panasonic.com/support” will be displayed.

3 Press **[OFF]**.

Programming via direct commands

You can also program most features using “direct commands”—special codes that take you directly to the feature you wish to program and allow you to select the desired setting. There is no need to scroll through the unit’s menus.

Details of each feature can be found on the corresponding pages.

- 1 Press **[MENU]**.
- 2 Enter the desired feature code (shown below).
- 3 Enter the desired setting code (shown below).
 - This step may vary depending on the feature being programmed.
- 4 Press **[Save]**.
- 5 Press **[OFF]** to exit programming mode.

Direct commands chart

Feature	Feature code	Setting code	Page
Ringer volume	[1] [1]	[1] : Low [2] : Medium [3] : High [0] : Off	page 31
Ringer tone	[1] [2]	[1]–[3] : Tone pattern 1–3 [4]–[7] : Melody pattern 1–4	page 31
VM access	[3]	Go to step 2 on page 29.	page 29
Voice enhancer	[5]	[1] : On [0] : Off	page 32
LCD contrast	[0] [1]	[1]–[6] : Level 1–6	page 33
Key tone	[0] [2]	[1] : On [0] : Off	page 34
Auto talk	[0] [3]	[1] : On [0] : Off	page 32
Caller ID number auto edit	[0] [4]	[1] : On [0] : Off	page 32
Set dial mode	[0] [5] [1]	[1] : Pulse [2] : Tone	page 33
Set flash time	[0] [5] [2]	[1] : 700 ms [2] : 600 ms [3] : 400 ms [4] : 300 ms [5] : 250 ms [6] : 110 ms [7] : 100 ms [8] : 90 ms	page 33
Set line mode	[0] [5] [3]	[1] : A [2] : B	page 34
Store VM access#	[0][7][1]	Go to step 5 on page 28.	page 28
VM tone detect	[0][7][2]	[1] : On [0] : Off	page 28
Change language	[0] [8]	[1] : English [2] : Spanish	page 33
Message alert	[0] [†]	[1] : On [0] : Off	page 29
Handset registration	[0] [0]	Go to step 4 on page 35.	page 35

Note:

- If you make a mistake or enter the wrong code, press **[OFF]** then start again by pressing **[MENU]**.

Wall mounting

The base unit can be mounted on a wall phone plate.

- 1** Connect the AC adaptor.

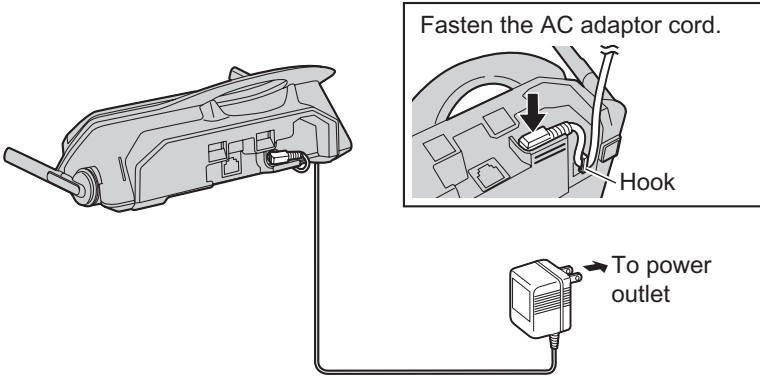

- 2** Tuck the telephone line cord inside the wall mounting adaptor (①).
Connect the telephone line cord (②).

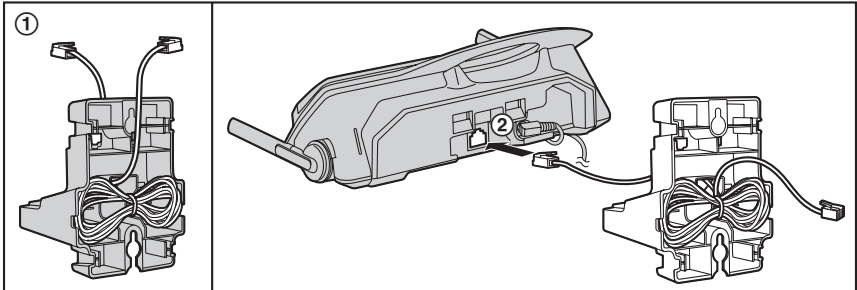

- 3** Insert the hooks on the wall mounting adaptor into the holes (A) and (B) on the base unit.

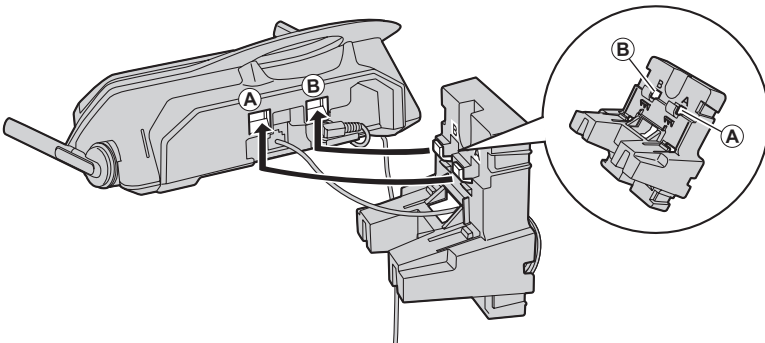

- 4** Adjust the adaptor to hold the base unit, then push it in the direction of the arrow until it clicks into place.

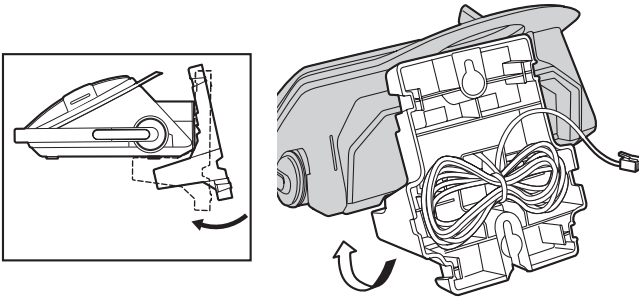

- 5** Connect the telephone line cord. Mount the unit, then slide it down.
- Raise the antennas.

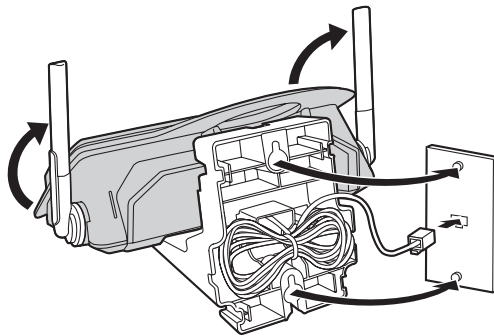

To remove the wall mounting adaptor

While pushing down the release levers (①), remove the adaptor (②).

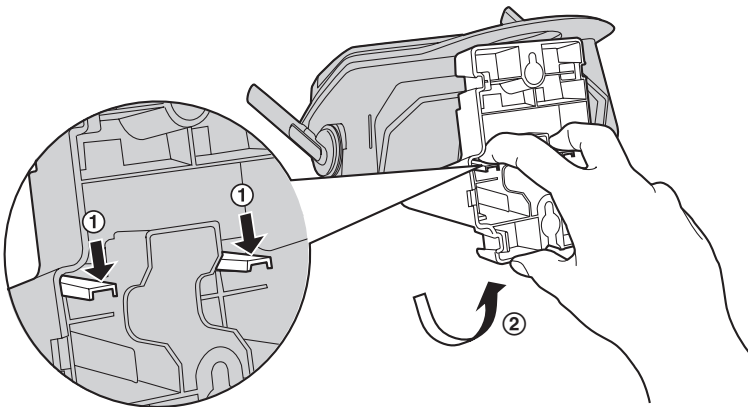

Belt clip

You can hang the handset on your belt or pocket using the included belt clip.

To attach the belt clip

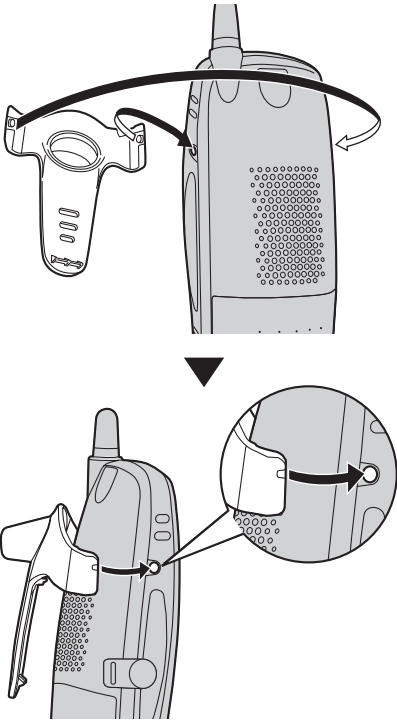

To remove the belt clip

While pressing the top of the clip (①), pull the right edge in the direction of the arrow (②).

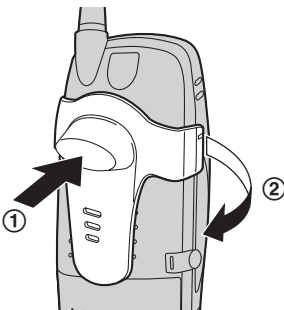

Headset (optional)

Connecting an optional headset to the handset allows hands-free phone conversations. Please use only a Panasonic headset. See page 5 for compatible headsets and ordering information.

To connect an optional headset to the handset

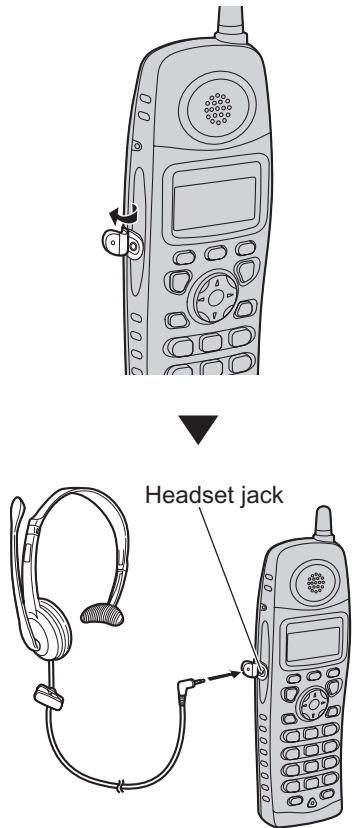

● Model shown is KX-TCA86.

Note:

- To switch to the speakerphone, press [⏏]. To return to the headset, press [📞].

Error messages

If the unit detects a problem, one of the following messages will be displayed on the handset.

Display message	Cause & solution
Error!!	<ul style="list-style-type: none"> ● When you tried to register the handset, the handset and the base unit could not link for some reason, such as interference from electrical appliances. Move the handset and the base unit away from the electrical appliances and try again.
No link to base. Move closer to base, try again.	<ul style="list-style-type: none"> ● The handset has lost communication with the base unit. Move closer to the base unit, and try again. ● Confirm that the base unit's AC adaptor is plugged in. ● Raise the base unit antennas. ● The handset's registration may have been canceled. Re-register the handset (page 35).
Phonebook full	<ul style="list-style-type: none"> ● There is no space to store new items in the phonebook. Erase unnecessary items (page 22).
No items stored	<ul style="list-style-type: none"> ● Your phonebook or redial list is empty.
Please lift up and try again.	<ul style="list-style-type: none"> ● A handset button was pressed while the handset was on the base unit. Lift the handset and press the button again.
System is busy. Please try again later.	<ul style="list-style-type: none"> ● The handset has lost communication with the base unit. Move closer to the base unit and try again.
Store VM access#	<ul style="list-style-type: none"> ● You have not stored the Voice Mail access number. Store the number (page 28).

Troubleshooting

General use

Problem	Cause & solution
The unit does not work.	<ul style="list-style-type: none">● Make sure that the battery is installed correctly (page 10).● Check the connections (page 9).● Fully charge the battery (page 11).● Clean the charge contacts and charge again (page 11).● Unplug the base unit's AC adaptor to reset the unit. Reconnect the adaptor and try again.● Re-install the battery (page 10) and fully charge it.
The display shows “No link to base. Move closer to base, try again.” and an alarm tone sounds.	<ul style="list-style-type: none">● The handset is too far from the base unit. Move closer and try again.● Plug in the base unit's AC adaptor.● Raise the base unit antennas.● If the above remedies do not solve the problem, the handset may have lost communication with the base unit. Register the handset again (page 35).
I cannot hear a dial tone.	<ul style="list-style-type: none">● Confirm that the telephone line cord is connected (page 9).● Disconnect the unit from the telephone line and connect a known working telephone. If the working telephone operates properly, contact our service personnel to have the unit repaired. If the working telephone does not operate properly, contact your telephone company.

Programmable settings

Problem	Cause & solution
I cannot program items.	<ul style="list-style-type: none">● Programming is not possible while the handset is being used.● Do not pause for over 1 minute while programming.● Move closer to the base unit.
While programming, the handset starts to ring.	<ul style="list-style-type: none">● A call is being received. Answer the call and start again from the beginning after hanging up.

Making/answering calls, Paging

Problem	Cause & solution
Static is heard, sound cuts in and out. Interference from other electrical units.	<ul style="list-style-type: none"> ● Move the handset and the base unit away from other electrical appliances. ● Move closer to the base unit. ● Raise the base unit antennas. ● Turn on the clarity booster feature (page 19). ● If your unit is connected to a telephone line with xDSL service, we recommend connecting a noise filter between the base unit and the telephone line jack. Contact your xDSL provider for details.
The handset does not ring.	<ul style="list-style-type: none"> ● The ringer volume is turned off. Adjust it (page 31).
I cannot make a call.	<ul style="list-style-type: none"> ● The dialing mode may be set incorrectly. Set the dial mode (page 33) to match the type of telephone service you have (tone or pulse).
I cannot redial by pressing [REDIAL] .	<ul style="list-style-type: none"> ● If the last number dialed was more than 48 digits long, the number will not be redialed correctly. ● If you press [REDIAL] after you have started dialing, this button functions as the [PAUSE] button. To redial, do not dial any numbers before pressing [REDIAL].
I cannot have a conversation using the headset.	<ul style="list-style-type: none"> ● Make sure that an optional headset is connected properly (page 40). ● If “SP-phone” is displayed on the handset, press [ to switch to the headset.
I cannot make long distance calls.	<ul style="list-style-type: none"> ● Make sure that you have long distance service.
I cannot page the handset.	<ul style="list-style-type: none"> ● The called handset is too far from the base unit. ● The called handset is in use. Try again later.

Phonebook





Problem	Cause & solution
I cannot store an item in the phonebook.	<ul style="list-style-type: none"> ● You cannot store an item in the phonebook while the handset is in talk or speakerphone mode. ● Do not pause for over 1 minute while storing.
While storing an item in the phonebook, the handset starts to ring.	<ul style="list-style-type: none"> ● A call is being received. Answer the call and start again from the beginning after hanging up.
The display exits the phonebook while searching.	<ul style="list-style-type: none"> ● The handset automatically exits after 1 minute of inactivity.

Useful Information

Caller ID

Problem	Cause & solution
The handset does not display the caller's name and/or phone number.	<ul style="list-style-type: none">● You have not subscribed to Caller ID service. Contact your telephone company to subscribe.● If your unit is connected to any additional telephone equipment such as Caller ID box or wireless telephone jack, disconnect the unit from the equipment and plug the unit directly into the wall jack.● If your unit is connected to a telephone line with xDSL service, we recommend connecting a noise filter between the base unit and the telephone line jack. Contact your xDSL provider for details.● The name display service may not be available in some areas. Contact your telephone company for details.● Other telephone equipment may be interfering with this unit. Disconnect the other equipment and try again.● The caller requested not to send caller information (page 24).● Generally caller information is displayed from the 2nd ring.
The caller list/incoming phone numbers are not edited automatically.	<ul style="list-style-type: none">● The Caller ID number auto edit feature is turned off. Turn it on and try again (page 32).● You need to call back the edited number to activate Caller ID number auto edit.
I cannot dial the phone number edited in the caller list.	<ul style="list-style-type: none">● The phone number you dialed might have an incorrect edited pattern (for example, the long distance "1" or the area code is missing). Edit the phone number with another pattern (page 26).
The display exits the caller list while searching.	<ul style="list-style-type: none">● The handset automatically exits after 1 minute of inactivity.

Battery charge

Problem	Cause & solution
“Recharge battery” is displayed,  flashes or the handset beeps intermittently.	<ul style="list-style-type: none"> Fully charge the battery (page 11).
“Charge for 6h” and  are displayed and the handset does not work.	<ul style="list-style-type: none"> The battery has been discharged. Fully charge the battery (page 11).
I charged the battery fully, but “Recharge battery” is still displayed and/or  continues to flash, or “Charge for 6h” and  are displayed.	<ul style="list-style-type: none"> Clean the charge contacts and charge again (page 11). The battery may need to be replaced (page 12). If you install a new battery, fully charge it (page 11).
The CHARGE indicator does not go out after the battery has been charged.	<ul style="list-style-type: none"> This is normal.
The handset display is blank.	<ul style="list-style-type: none"> Confirm that the battery is properly installed. Fully charge the battery (page 11).

Power failure

Problem	Cause & solution
The unit will not function.	<ul style="list-style-type: none"> This product is not designed to make calls in the event of a power failure. We recommend connecting a standard telephone to the same telephone line in the event that emergency calls need to be made during a power failure (page 9).

Important information about subscription services

In order to use Caller ID, Call Waiting, Call Waiting Caller ID (CWID), or Voice Mail, you must first contact your telephone company and subscribe to the desired service.

- For more information, contact your telephone company.

If the Call Waiting Caller ID (CWID) feature does not function:

- You may need to contact your telephone company to activate this specific service, even if you already subscribed to both Caller ID and Call Waiting with Caller ID services (CWID).

FCC and other information

This equipment complies with Part 68 of the FCC rules and the requirements adopted by the ACTA. On the bottom of this equipment is a label that contains, among other information, a product identifier in the format US:ACJ-----.

If requested, this number must be provided to the telephone company.

- Registration No
.....(found on the bottom of the unit)
- Ringer Equivalence No. (REN).....0.1B

A plug and jack used to connect this equipment to the premises wiring and telephone network must comply with the applicable FCC Part 68 rules and requirements adopted by the ACTA. A compliant telephone cord and modular plug is provided with this product. It is designed to be connected to a compatible modular jack that is also compliant.

The REN is used to determine the number of devices that may be connected to a telephone line. Excessive RENs on a telephone line may result in the devices not ringing in response to an incoming call. In most but not all areas, the sum of RENs should not exceed five (5.0). To be certain of the number of devices that may be connected to a line, as determined by the total RENs, contact the local telephone company. For products approved after July 23, 2001, the REN for this product is part of the product identifier that has the format US:AAAEQ##TXXXX. The digits represented by ## are the REN without a decimal point (e.g., 03 is a REN of 0.3).

If this equipment causes harm to the telephone network, the telephone company will notify you in advance that temporary discontinuance of service may be required. But if advance notice isn't practical, the telephone company will

notify the customer as soon as possible. Also, you will be advised of your right to file a complaint with the FCC if you believe it is necessary.

The telephone company may make changes in its facilities, equipment, operations or procedures that could affect the operation of the equipment. If this happens the telephone company will provide advance notice in order for you to make necessary modifications to maintain uninterrupted service.

If trouble is experienced with this equipment, for repair or warranty information, please contact a Factory Servicenter or other Authorized Servicer. If the equipment is causing harm to the telephone network, the telephone company may request that you disconnect the equipment until the problem is resolved.

Connection to party line service is subject to state tariffs. Contact the state public utility commission, public service commission or corporation commission for information.

If your home has specially wired alarm equipment connected to the telephone line, ensure the installation of this equipment does not disable your alarm equipment. If you have questions about what will disable alarm equipment, consult your telephone company or a qualified installer.

This equipment is hearing aid compatible as defined by the FCC in 47 CFR Section 68.316.

Useful Information

When you hold the phone to your ear, noise might be heard in your Hearing Aid. Some Hearing Aids are not adequately shielded from external RF (radio frequency) energy. If noise occurs, use an optional headset accessory or the speakerphone option (if applicable) when using this phone. Consult with your audiologist or Hearing Aid manufacturer about the availability of Hearing Aids which provide adequate shielding to RF energy commonly emitted by digital devices.

WHEN PROGRAMMING EMERGENCY NUMBERS AND(OR) MAKING TEST CALLS TO EMERGENCY NUMBERS:

- 1) Remain on the line and briefly explain to the dispatcher the reason for the call.
- 2) Perform such activities in the off-peak hours, such as early morning or late evenings.

This device complies with Part 15 of the FCC Rules. Operation is subject to the following two conditions:

(1) This device may not cause harmful interference, and (2) this device must accept any interference received, including interference that may cause undesired operation.

Privacy of communications may not be ensured when using this phone.

CAUTION:

Any changes or modifications not expressly approved by the party responsible for compliance could void the user's authority to operate this device.

NOTE:

This equipment has been tested and found to comply with the limits for a Class B digital device, pursuant to Part 15 of the FCC Rules. These limits are designed to provide reasonable protection against harmful interference in a residential installation. This equipment generates, uses, and can radiate radio frequency energy and, if not installed and used in accordance with the instructions, may cause harmful interference to radio communications. However, there is no guarantee that interference will not occur in a particular installation. If this equipment does cause harmful interference to radio or television reception, which can be determined by turning the equipment off and on, the user is encouraged to try to correct the interference by one or more of the following measures:

- Reorient or relocate the receiving antenna.
- Increase the separation between the equipment and receiver.
- Connect the equipment into an outlet on a circuit different from that to which the receiver is connected.
- Consult the dealer or an experienced radio/TV technician for help.

Some cordless telephones operate at frequencies that may cause interference to nearby TVs and VCRs. To minimize or prevent such interference, the base of the cordless telephone should not be placed near or on top of a TV or VCR. If interference is experienced, move the cordless telephone further away from the TV or VCR. This will often reduce, or eliminate, interference.

FCC RF Exposure Warning:

This product complies with FCC radiation exposure limits set forth for an uncontrolled environment. To comply with FCC RF exposure requirements the base unit must be installed and operated with its antenna located 20 cm or more between antenna and all person's body (excluding extremities of hands, wrist and feet). The handset unit may be carried and operated with only the specific provided belt-clip. Other non-tested belt-clips or similar body-worn accessories may not comply and must be avoided. The base and handset units must not be co-located or operated in conjunction with any other antenna or transmitter.

Technical information

Base unit

Operating environment:

5 °C – 40 °C (41 °F – 104 °F)

Frequency:

5.76 GHz – 5.84 GHz

Dimensions:

Approx. height 75 mm x width 185 mm x depth 119 mm (2¹⁵/₁₆" x 7⁹/₃₂" x 4¹¹/₁₆")

Mass (Weight):

Approx. 360 g (0.79 lb.)

Power consumption:

Standby: Approx. 2.3 W

Maximum: Approx. 5.5 W

Power supply:

AC adaptor (120 V AC, 60 Hz)

Handset

Operating environment:

5 °C – 40 °C (41 °F – 104 °F)

Frequency:

5.76 GHz – 5.84 GHz

Dimensions:

Approx. height 178 mm x width 53 mm x depth 37 mm (7" x 2³/₃₂" x 1¹⁵/₃₂")

Mass (Weight):

Approx. 190 g (0.42 lb.)

Power supply:

Ni-MH battery (3.6 V, 830 mAh)

Security codes:

1,000,000

Note:

- Design and specifications are subject to change without notice.

- The illustrations in these instructions may vary slightly from the actual product.

Warranty

PANASONIC CONSUMER
ELECTRONICS COMPANY, DIVISION
OF MATSUSHITA ELECTRIC
CORPORATION OF AMERICA
One Panasonic Way
Secaucus, New Jersey 07094

PANASONIC SALES COMPANY,
DIVISION OF MATSUSHITA
ELECTRIC OF PUERTO RICO, INC.,
Ave. 65 de Infanteria, Km. 9.5
San Gabriel Industrial Park
Carolina, Puerto Rico 00985

Panasonic Telephone Products Limited Warranty

Limited Warranty Coverage

If your product does not work properly because of a defect in materials or workmanship, Panasonic Consumer Electronics Company or Panasonic Sales Company (collectively referred to as "the warrantor") will, for the length of the period indicated on the chart below, which starts with the date of original purchase ("Limited Warranty period"), at its option either (a) repair your product with new or refurbished parts, or (b) replace it with a new or a refurbished product. The decision to repair or replace will be made by the warrantor.

Parts

One (1) Year

Labor

One (1) Year

During the "Labor" Limited Warranty period there will be no charge for labor. During the "Parts" Limited Warranty period, there will be no charge for parts. You must mail-in your product during the Limited Warranty period. This Limited Warranty excludes both parts and labor for batteries, antennas, and cosmetic parts (cabinet). This Limited Warranty only applies to products purchased and serviced in the United States or Puerto Rico. This Limited Warranty is extended only to the original purchaser and only covers products purchased as new.

Mail-In Service

For assistance in the continental U.S.A. in obtaining repairs please ship the product to:

Panasonic Services Company Customer Servicer

4900 George McVay Drive Suite B Door #12 McAllen, TX 78503

For assistance in Puerto Rico call Panasonic Sales Company (787)-750-4300 or fax (787)-768-2910.

For Limited Warranty service for headsets if a headset is included with this product please call Panasonic Call Center at 1-800-211-PANA (7262).

When shipping the unit carefully pack, include all accessories, and send it prepaid, adequately insured and preferably in the original carton. Include a letter detailing the complaint and provide a day time phone number where you can be reached.

IF REPAIR IS NEEDED DURING THE LIMITED WARRANTY PERIOD THE PURCHASER WILL BE REQUIRED TO FURNISH A SALES RECEIPT/PROOF OF PURCHASE INDICATING DATE OF PURCHASE, AMOUNT PAID AND PLACE OF PURCHASE. CUSTOMER WILL BE CHARGED FOR THE REPAIR OF ANY UNIT RECEIVED WITHOUT SUCH PROOF OF PURCHASE.

Limited Warranty Limits And Exclusions

This Limited Warranty ONLY COVERS failures due to defects in materials or workmanship, and DOES NOT COVER normal wear and tear or cosmetic damage. The Limited Warranty ALSO DOES NOT COVER damages which occurred in shipment, or failures which are caused by products not supplied by the warrantor, or failures which result from accidents, misuse, abuse, neglect, mishandling, misapplication, alteration, faulty installation, set-up adjustments, misadjustment of consumer controls, improper maintenance, power line surge, lightning damage, modification, introduction of sand, humidity or liquids, commercial use such as hotel, office, restaurant, or other business or rental use of the product, or service by anyone other than a Factory Servicenter or other Authorized Servicer, or damage that is attributable to acts of God.

THERE ARE NO EXPRESS WARRANTIES EXCEPT AS LISTED UNDER “LIMITED WARRANTY COVERAGE”. THE WARRANTOR IS NOT LIABLE FOR INCIDENTAL OR CONSEQUENTIAL DAMAGES RESULTING FROM THE USE OF THIS PRODUCT, OR ARISING OUT OF ANY BREACH OF THIS LIMITED WARRANTY. (As examples, this excludes damages for lost time, lost calls or messages, cost of having someone remove or re-install an installed unit if applicable, travel to and from the servicer. The items listed are not exclusive, but are for illustration only.) **ALL EXPRESS AND IMPLIED WARRANTIES, INCLUDING THE WARRANTY OF MERCHANTABILITY, ARE LIMITED TO THE PERIOD OF THE LIMITED WARRANTY.**

Some states do not allow the exclusion or limitation of incidental or consequential damages, or limitations on how long an implied warranty lasts, so the exclusions may not apply to you.

This Limited Warranty gives you specific legal rights and you may also have other rights which vary from state to state. If a problem with this product develops during or after the Limited Warranty period, you may contact your dealer or Servicenter. If the problem is not handled to your satisfaction, then write to the warrantor’s Consumer Affairs Department at the addresses listed for the warrantor.

PARTS AND SERVICE, WHICH ARE NOT COVERED BY THIS LIMITED WARRANTY, ARE YOUR RESPONSIBILITY.

Customer services

Customer Services Directory

Obtain Product Information and Operating Assistance; locate your nearest Dealer or Servicenter; purchase Parts and Accessories; or make Customer Service and Literature requests by visiting our Web Site at:

<http://www.panasonic.com/consumersupport>

or, contact us via the web at:

<http://www.panasonic.com/contactinfo>

You may also contact us directly at: 1-800-211-PANA (7262),
Monday-Friday 9 am-9 pm; Saturday-Sunday 10 am-7 pm, EST.

TTY users (hearing or speech impaired users) can call 1-877-833-8855.

Accessory Purchases

Purchase Parts, Accessories and Instruction Books online for all Panasonic Products by visiting our Web Site at:

<http://www.pasc.panasonic.com>

or, send your request by E-mail to:

npcparts@us.panasonic.com

You may also contact us directly at:

1-800-332-5368 (Phone) 1-800-237-9080 (Fax Only)

(Monday - Friday 9 am to 8 pm, EST.)

Panasonic Services Company

20421 84th Avenue South, Kent, WA 98032

(We Accept Visa, MasterCard, Discover Card, American Express, and Personal Checks)

TTY users (hearing or speech impaired users) can call 1-866-605-1277.

Service in Puerto Rico

Matsushita Electric of Puerto Rico, Inc. Panasonic Sales Company

Factory Servicenter:

Ave. 65 de Infantería, Km. 9.5, San Gabriel Industrial Park,

Carolina, Puerto Rico 00985

Phone (787)750-4300, Fax (787)768-2910

Index

- A** Accessories: 5
 - Answering calls: 17
 - Auto talk: 17, 32
- B** Backlit display: 15
 - Backlit handset keypad: 15
 - Base unit location: 8
 - Battery
 - Charge: 11
 - Installation: 10
 - Performance: 12
 - Replacement: 12
 - Strength: 11
 - Belt clip: 40
- C** Caller ID edit: 32
 - Caller ID number auto edit: 26
 - Caller ID service: 24
 - Caller list
 - Calling back: 25
 - Editing: 26
 - Erasing: 27
 - Storing: 27
 - Viewing: 25
 - Call Waiting Caller ID: 24
 - Call waiting tone: 20
 - Chain dial: 23
 - Clarity booster: 19
 - Controls: 13
 - Customer support: 35
- D** Dialing mode: 33
 - Display: 15
 - Display language: 33
- E** Error messages: 41
- F** FCC and other information: 47
 - Flash button: 19
 - Flash time: 33
 - Function menu
 - Direct commands: 36
 - Table: 30
- H** Handset locator: 20
 - Headset, optional: 40
 - Hold: 18
- I** Installation
 - AC adaptor: 9
 - Base unit: 9
 - Telephone line cord: 9
- K** Key tone: 34
- L** LCD contrast: 33
 - Light-up ID: 25
 - Line mode: 34
- M** Making calls: 16
 - Message alert: 29
 - Microphone: 16
 - Mute: 18
- N** Navigator key: 14
 - Noise: 8
- P** Pause: 19
 - Phonebook
 - Adding: 21
 - Calling: 22
 - Editing: 22
 - Erasing: 22
 - Names: 21
 - Power failure: 9, 45
 - Pulse service: 20
- R** Redial: 16
 - Redial list: 17
 - Registration: 35
 - Ringer
 - Tone: 31
 - Volume: 31
 - Ringer ID: 24
 - Ringer off: 17, 31
 - Rotary service, tone dialing: 20
- S** Safety instructions: 6
 - Soft keys: 15
 - SP-phone: 16
- T** Technical information: 50
 - Troubleshooting
 - Battery charge: 45
 - Caller ID: 44
 - General use: 42
 - Making/answering calls, Paging: 43
 - Phonebook: 43
 - Power failure: 45
 - Programmable settings: 42
 - TTY: 5
- V** VE (voice enhancer): 18
 - VM (Voice Mail): 28
 - Voice enhancer: 18, 32
 - Voice Mail access number: 28

Volume control

Handset receiver: 16

Handset speaker: 16

W Wall mounting: 38

Warranty: 51

If you need assistance with setup or operation;

- 1** Visit our website: <http://www.panasonic.com/consumersupport>
- 2** Contact us via the web at: <http://www.panasonic.com/contactinfo>
- 3** Call us at: 1-800-211-PANA (7262)
TTY users (hearing or speech impaired users) can call 1-877-833-8855.

When you ship the product;

- Carefully pack your unit, preferably in the original carton.
- Attach a letter, detailing the symptom, to the outside of the carton.
- Send the unit to Panasonic Services Company Customer Servicenter, prepaid and adequately insured.
- Do not send your unit to Panasonic Consumer Electronics Company listed below or to executive or regional sales offices. These locations do not repair consumer products.

- | |
|-------------------------------------------------------------------------------------------------------------------------------------------------------------------------------------------------------------------------------------------------------------------------------------------------------------------------------------------------------------------------------------------------------------------------------------------------------------------------------------------------------------------------------------------------------------------------------------------------------------------------------------------------------------------------------------------------------------------------------------|
| <ul style="list-style-type: none">• This cordless telephone is designed for use in the United States of America. Sale or use of this product in other countries may violate local laws.• Ce téléphone sans fil est conçu pour être utilisé aux États-Unis d'Amérique. La vente ou l'emploi de cet appareil dans certains autres pays peut constituer une infraction à la législation locale.• Este teléfono inalámbrico fue elaborado para uso en los Estados Unidos de América. La venta o el empleo de este producto en ciertos países puede constituir violación de la legislación local.• このコードレス電話機は、日本国外での使用を目的として設計されており、日本国内での使用は法律違反となります。従って、当社では日本国内においては原則として修理などのサービスは致しかねます。 |
|-------------------------------------------------------------------------------------------------------------------------------------------------------------------------------------------------------------------------------------------------------------------------------------------------------------------------------------------------------------------------------------------------------------------------------------------------------------------------------------------------------------------------------------------------------------------------------------------------------------------------------------------------------------------------------------------------------------------------------------|

Copyright:

This material is copyrighted by Panasonic Communications Co., Ltd., and may be reproduced for internal use only. All other reproduction, in whole or in part, is prohibited without the written consent of Panasonic Communications Co., Ltd.

© 2004 Panasonic Communications Co., Ltd. All Rights Reserved.

**Panasonic Consumer Electronics Company,
Division of Matsushita Electric Corporation of America**
One Panasonic Way, Secaucus, New Jersey 07094

**Panasonic Sales Company,
Division of Matsushita Electric of Puerto Rico, Inc.**
Ave. 65 de Infantería, Km. 9.5, San Gabriel Industrial Park
Carolina, Puerto Rico 00985